

Aluminium Tracking

All the **NMI** products contained within this brochure are tested and designed for usage in **NMI** Aluminium Tracking profiles.

Tracking is supplied in 12ft lengths, 3657mm.

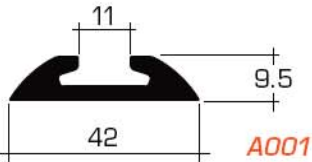

A001

Part A001 Round Track
Part A001/C6 Round Track, Countersunk 6mm

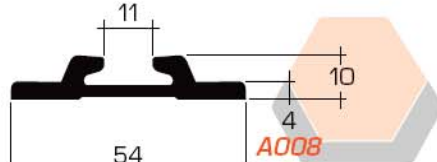

A008

Part A008 Captive Track

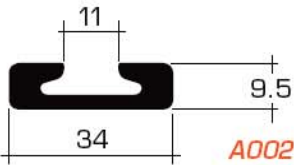

A002

Part A002 Square Track

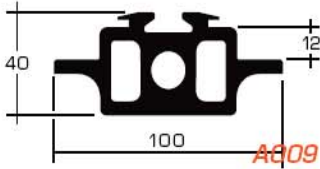

A009

Part A009 Floor Track System

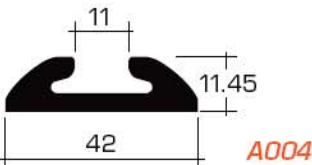

A004

Part A004 Heavy Duty Round Track
Part A004/C6 Heavy Duty Round Track, Countersunk 6mm

Aluminium Tracking

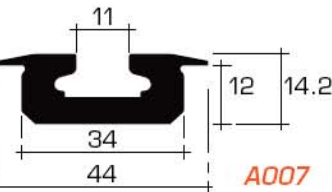
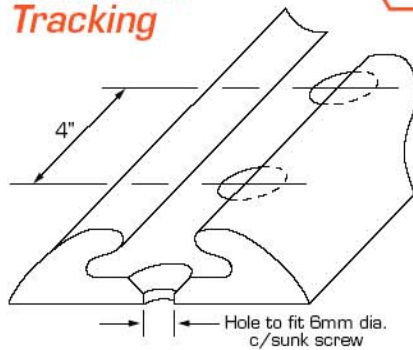

A007

Part A007 Heavy Duty Inset Track with punched holes every inch
Part A007/C6 Heavy Duty Inset Track, Countersunk 6mm
Part A007/C8 Heavy Duty Inset Track, Countersunk 8mm
Part M/A007/C8 Millennium H/D Straight Inset Track, Countersunk 8mm

Tracking Profiles

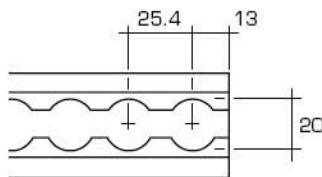

A008

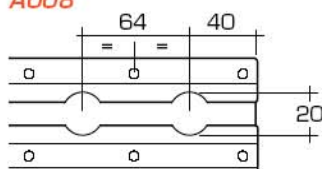

Tracking Accessories

Track End Caps ease cleaning out the channel and protect the end of the track.

Part P102

Track End Cap for Heavy Duty Inset Track profiles

Part P102/R

Track End Cap for Round Track profiles

Rubber track inserts will protect against debris and spillages. Supplied in 24" lengths.

P103

Punched Rubber Rail Insert

PM103

Rubber Rail Insert for Straight channel Track